



WHITE-RODGERS

1F82-261

Programmable Electronic Digital
Heat Pump Thermostat
**INSTALLATION AND
OPERATION INSTRUCTIONS**

Operator: Save these instructions for future use!

**FAILURE TO READ AND FOLLOW ALL INSTRUCTIONS CAREFULLY
BEFORE INSTALLING OR OPERATING THIS CONTROL COULD CAUSE
PERSONAL INJURY AND/OR PROPERTY DAMAGE.**

DESCRIPTION

Your new White-Rodgers 5-Day/1-Day/1-Day Digital Thermostat uses the technology of a solid-state microcomputer to provide precise time/temperature control. This thermostat offers you the flexibility to design heating and cooling programs that fit your needs.

Features:

- Separate 5-day (weekday) and 1-day/1-day (Saturday/Sunday) programming with four separate time/temperature periods per day
- Simultaneous heat and cool program storage
- Preprogrammed temperature control
- Optional battery back-up for AC power loss

- LCD continuously displays set point, and alternately displays time and room temperature
- Continuous Backlit display option
- Temperature override until next program period
- Manual program override (HOLD temperature)
- Temporary HOLD
- °F/°C convertibility
- Temperature range 45° to 90°F
- R, C, Y, W2, G, O/B, E, and L terminals for single or two-transformer systems

PRECAUTIONS

This thermostat is intended for use with a low voltage NEC Class II system. Do not use this thermostat with a line voltage system. If in doubt about whether your wiring is millivolt, line, or low voltage, have it inspected by a qualified heating and air conditioning contractor or electrician.

Do not exceed the specification ratings.

All wiring must conform to local and national electrical codes and ordinances.

This control is a precision instrument, and should be handled carefully. Rough handling or distorting components could cause the control to malfunction.

CAUTION

To prevent electrical shock and/or equipment damage, disconnect electric power to system at main fuse or circuit breaker box until installation is complete.

WARNING

Do not use on circuits exceeding specified voltage. Higher voltage will damage control and could cause shock or fire hazard.

Do not short out terminals on gas valve or primary control to test. Short or incorrect wiring will damage thermostat and could cause personal injury and/or property damage.

Thermostat installation and all components of the system shall conform to Class II (current limited) circuits per the NEC code. Failure to do so could cause a fire hazard.

SPECIFICATIONS

ELECTRICAL DATA

Electrical Rating:

- 20 to 30 VAC 50/60 Hz. or D.C.
- 0.05 to 1.0 Amps (Load per terminal)
- 1.5 Amps Maximum Total Load** (All terminals combined)

THERMAL DATA

Setpoint Temperature Range:

45°F to 90°F (7°C to 32°C)

Operating Ambient Temperature Range:

32°F to 105°F

Operating Humidity Range:

0 to 90% RH (non-condensing)

Shipping Temperature Range:

-4°F to 149°F

APPLICATIONS

For use with the following Class II systems:

- Standard heat pump systems with electric, gas or oil Aux heat with 24VAC Hot and Common available
- Single-stage heat pump systems with no Aux heat with 24VAC Hot and Common available

DO NOT USE WITH:

- Millivolt systems
- Systems exceeding 30 VAC and 1.5 amps
- 3-wire zoned hydronic heating systems

INSTALLATION

REMOVE OLD THERMOSTAT

1. Shut off electricity at the main fuse box until installation is complete. Ensure that electrical power is disconnected.
2. Remove the front cover of the old thermostat. **With wires still attached**, remove wall plate from the wall. If the old thermostat has a wall mounting plate, remove the thermostat and the wall mounting plate as an assembly.
3. **Identify each wire attached to the old thermostat using the labels enclosed with the new thermostat.**
4. Disconnect the wires from old thermostat one at a time. **DO NOT LET WIRES FALL BACK INTO THE WALL.**
5. Install new thermostat using the following procedures.

ATTENTION!

This product does not contain mercury. However, this product may replace a unit which contains mercury.

Do not open mercury cells. If a cell becomes damaged, do not touch any spilled mercury. Wearing nonabsorbent gloves, take up the spilled mercury and place into a container which can be sealed. If a cell becomes damaged, the unit should be discarded.

Mercury must not be discarded in household trash. When the unit this product is replacing is to be discarded, place in a suitable container and return to White-Rodgers at 9797 Reavis Road, St. Louis, MO, 63123-5398 for proper disposal.

ATTACH THERMOSTAT BASE TO WALL

1. Remove the packing material from the thermostat. Gently pull the cover straight off the base. Forcing or prying on the thermostat will cause damage to the unit.
2. Connect wires beneath terminal screws on base using appropriate wiring schematic (see figs. 2 through 4).
3. Place base over hole in wall and mark mounting hole locations on wall using base as a template.
4. Move base out of the way. Drill mounting holes.
5. Fasten base loosely to wall, as shown in fig. 1, using two mounting screws. Place a level against bottom of base, adjust until level, and then tighten screws. (Leveling is for appearance only and will not affect thermostat operation.) If you are using existing mounting holes, or if holes drilled are too large and do not allow you to tighten base snugly, use plastic screw anchors to secure subbase.
6. Push excess wire into wall and plug hole with a fire-resistant material (such as fiberglass insulation) to prevent drafts from affecting thermostat operation.

ELECTRIC/GAS JUMPER (Fan Option)

Read the following information before clipping the nonelectric heat jumper. If you are unsure of your application, contact a qualified service person.

If your emergency or auxiliary system will energize the blower, then jumper, W904, on the thermostat base must be cut (see fig. 1).

If your emergency or auxiliary heat system requires that the thermostat energize the fan circuit, do not cut jumper W904.

OPTIONAL BATTERIES

With two "AA" batteries installed, your thermostat will maintain time and continuously display the temperature during a loss

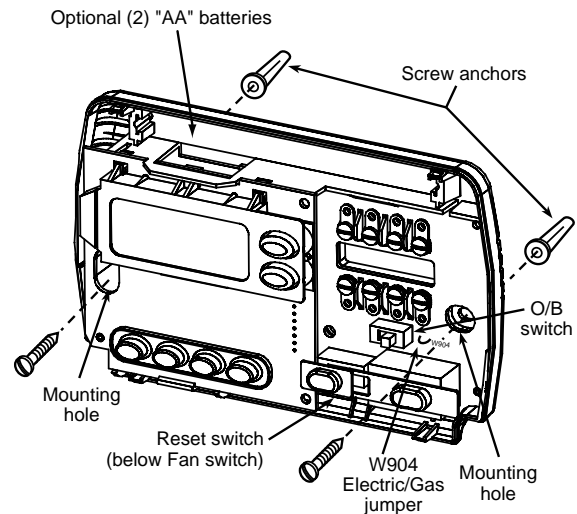

Figure 1. Thermostat Base

of AC power. Installed batteries will also allow programming prior to installation.

ENERGY MANAGEMENT RECOVERY (EMR)

When the EMR feature is activated the thermostat's microcomputer calculates the time it will take to change the room temperature to the next heat or cool program setting. Then the thermostat will start the system before the next programmed period so that the desired temperature is reached at or near the beginning of the period (the thermostat calculates 15 minutes for every 1°F temperature change). This minimizes the use of auxiliary stages during the transition period to reduce energy costs.

For example: The thermostat is programmed to provide an overnight heating temperature of 66°F, and during the next program period, beginning at 6:00 AM, the programmed temperature is 70°F. With EMR activated, the thermostat will automatically start the heating system at 5:00 AM, so that the programmed temperature of 70°F is reached by about 6:00 AM.

If the overnight room temperature drops only to 68°F, the thermostat will start the system at 5:30 to reach the programmed temperature of 70°F at 6:00.

The thermostat is shipped with the EMR feature **active**, which means that the thermostat will start the heating system before the beginning of the next program period. This feature provides better efficiency by allowing gradual temperature changes using only the first stage of heat.

To deactivate the EMR function, see the Configuration menu on Page 5). The thermostat will then wait until the programmed time to start the system for a temperature change.

O/B TERMINAL SWITCH SELECTION

The O/B switch on this thermostat is factory set to the "O" position. This will accommodate the majority of heat pump applications, which require the changeover relay to be energized in COOL. If the thermostat you are replacing or the heat pump being installed with this thermostat requires a "B" terminal, to energize the changeover relay in HEAT, the O/B switch must be moved to the "B" position.

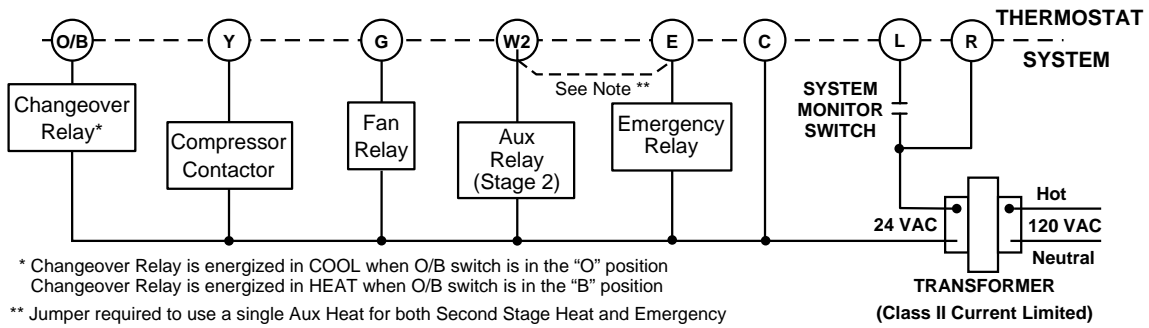

Figure 2. Typical wiring diagram for single transformer systems

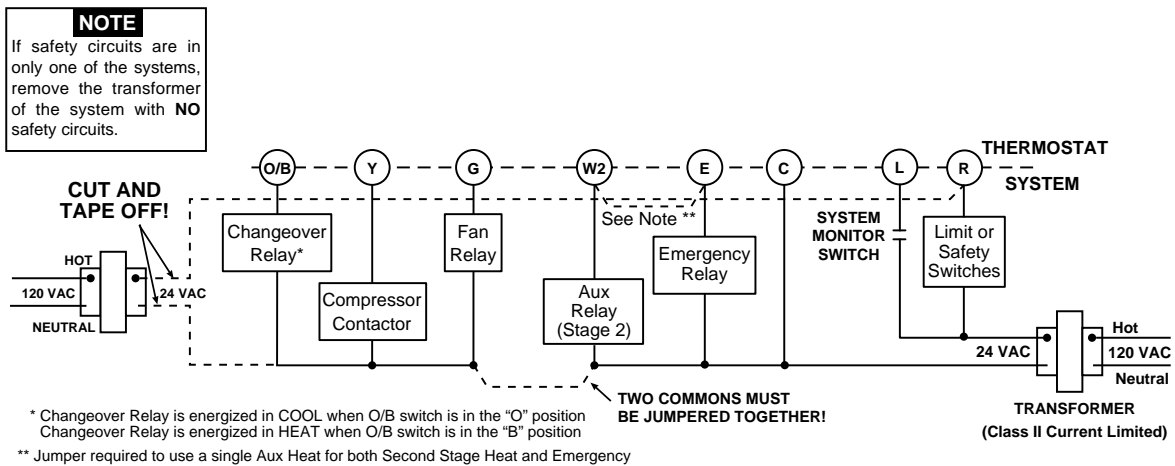

Figure 3. Typical wiring diagram for two transformer systems with NO safety circuits

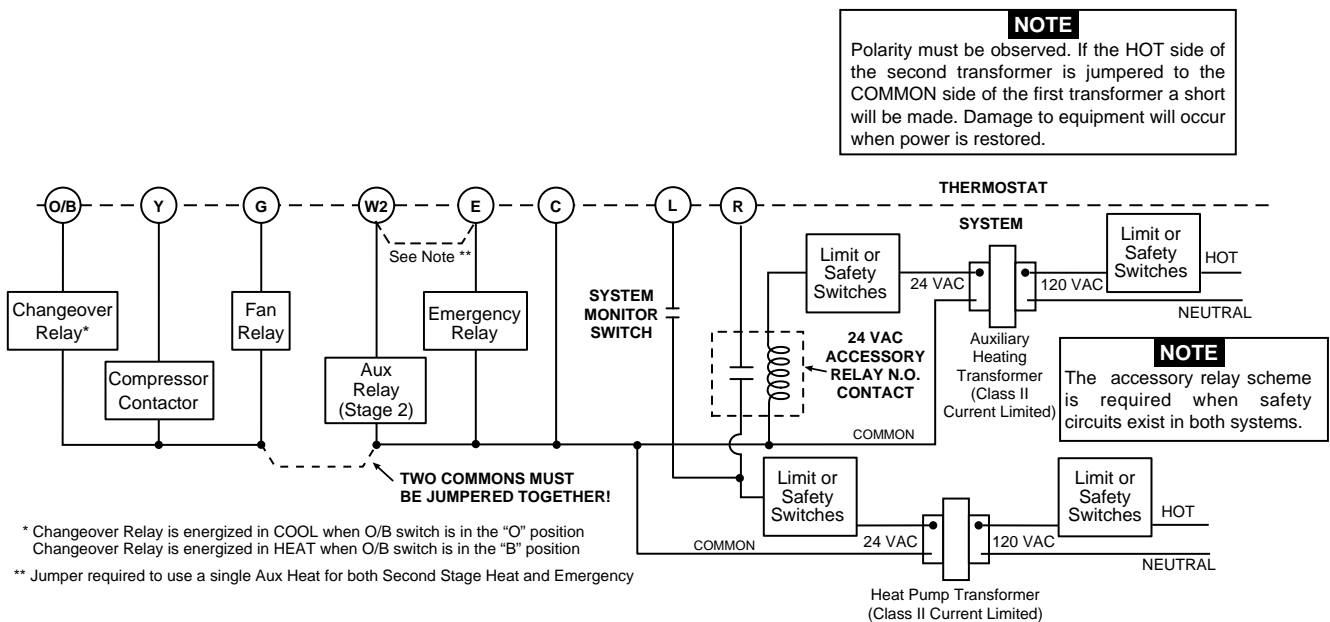

Figure 4. Typical wiring diagram for two transformer systems with safety circuits in BOTH systems

CHECK THERMOSTAT OPERATION

If at any time during testing your system does not operate properly, contact a qualified service person.

Turn on power to the system.

Fan Operation

If your system **does not** have a **G** terminal connection, skip to **Heating System**.

1. Move fan switch to **ON** position. The blower should begin to operate.
2. Move fan switch to **AUTO** position. The blower should stop immediately.

Heating System

1. Move SYSTEM switch to **HEAT** position. If the auxiliary heating system has a standing pilot, be sure to light it.
2. Press \triangleleft to adjust thermostat setting to 1° above room temperature. The Heat Pump system should begin to operate. However, if the **Flame icon** (Δ) and **Snowflake icon** (\ast) are flashing, the compressor lockout feature is operating (see Configuration menu, item 7).
3. Adjust temperature setting to 4° above room temperature. The auxiliary heat system should begin to operate and the **Flame icon** will be flashing.
4. Press \triangleright to adjust temperature setting below room temperature. The heating system should stop operating.

Emergency System

EMER bypasses the Heat Pump to use the heat source wired to terminal E on the thermostat. EMER is typically used when compressor operation is not desired, or you prefer back-up heat only.

1. Move SYSTEM switch to EMER position, EMER will flash on the display.
2. Press \triangleleft to adjust the thermostat above room temperature. The Aux heating system will begin to operate. The **Flame icon** (Δ) will display flashing to indicate that the Aux system is operating.
3. Press \triangleright to adjust the thermostat below room temperature. The Aux heating system should stop operating.

Cooling System

⚠ CAUTION

To prevent compressor and/or property damage, if the outdoor temperature is below 50°F, DO NOT operate the cooling system.

1. Move SYSTEM switch to **COOL** position.
2. Press \triangleright to adjust thermostat setting below room temperature. The blower should come on immediately on high speed, followed by cold air circulation
3. Press \triangleleft to adjust temperature setting above room temperature. The cooling system should stop operating.

⚠ CAUTION

Do not allow the compressor to run unless the compressor oil heaters have been operational for 6 hours and the system has not been operational for at least 5 minutes.

OPERATION

Before you begin programming your thermostat, you should be familiar with its features and with the display and the location and operation of the thermostat buttons. Your thermostat consists of two parts: the **thermostat cover** and the **base**. To remove the cover, pull it straight out from the base. To replace the cover, line up the cover with the base and press until the cover snaps onto the base.

THE THERMOSTAT BASE

Other than \triangleleft and \triangleright , the following buttons and switches are located on the bottom of the thermostat cover (see fig. 5).

The Thermostat Buttons and Switches

- ① Raises temperature setting.
- ② Lowers temperature setting.
- ③ TIME button.
- ④ PRGM (program) button.
- ⑤ RUN (program) button.
- ⑥ HOLD temperature button.
- ⑦ FAN switch (**ON**, **AUTO**).
- ⑧ SYSTEM switch (**COOL**, **OFF**, **HEAT**, **EMER**).

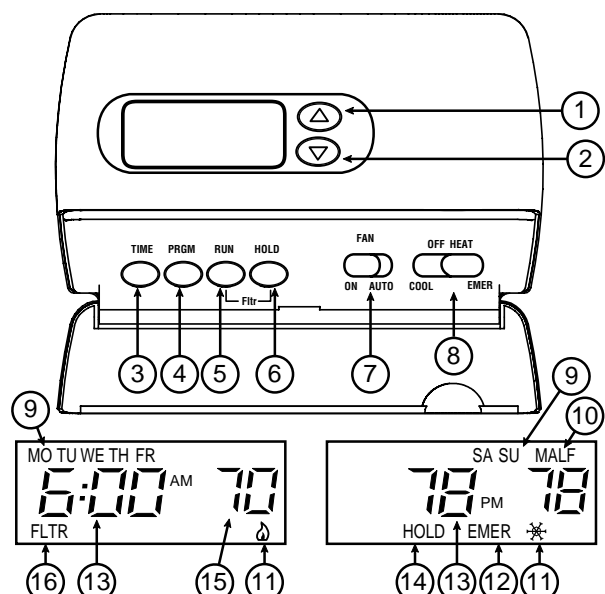

Figure 5. Thermostat display, buttons, and switches

The Display

- ⑨ Indicates day of the week.
- ⑩ Indicates a malfunction with the system.
- ⑪ **Flame icon** (Δ) is displayed when the SYSTEM switch is in the HEAT position. **Flame icon** (Δ) is displayed flashing when 2nd-stage heat (Aux or Emergency) is energized. **Snowflake icon** (❄) is displayed (non-flashing) when the SYSTEM switch is in the COOL position. **Snowflake** and **Flame** are displayed (flashing) if the thermostat is in lockout mode to prevent the compressor from cycling too quickly.
- ⑫ **EMER** is displayed flashing when the system switch is in EMER position.
- ⑬ Alternately displays current time and temperature.
- ⑭ The word **HOLD** is displayed when the thermostat is in the HOLD mode. **HOLD** is displayed flashing when the thermostat is in a temporary HOLD Mode.
- ⑮ Displays currently programmed set temperature (this is blank when SYSTEM switch is in the OFF position).
- ⑯ Displays **FLTR** when the system has run for the programmed filter time period as a reminder to change or clean your air filter.

CONFIGURATION MENU

The configuration menu allows you to set certain thermostat operating characteristics to your system or personal requirements.

Press RUN to make sure the thermostat is in the run program mode, then press PRGM and RUN at the same time to enter the configuration menu. The display will show the first item in the configuration menu.

The configuration menu chart summarizes the configuration options. An explanation of each option follows.

Press HOLD to change to the next menu item or press TIME to go backwards to the previous item in the menu. To exit the menu and return to the program operation, press RUN. If no keys are pressed within fifteen minutes, the thermostat will revert to normal operation.

1) Select Temporary Hold Time - The thermostat can hold any temperature you set it to for the amount of time you select on this option. Your choices are 0:00 to 8:00 hours in 15 minute increments. 0:00 disables the function

Example: Using the Temporary Hold Function

1. You have selected 3:00 hours for the Temporary Hold time period.
2. With the thermostat set to Heat or Cool, press HOLD for **five seconds** (time will show 3:00 hours as a setting reminder).
3. **HOLD** on the display will blink. Release the HOLD button after the temporary hold time is displayed.
4. Use ▲ or ▼ to set the temperature to your preference. The thermostat will maintain this temperature setting for 3 hours with **HOLD** blinking to remind you it is in Temporary Hold. After 3 hours the thermostat will go back to the program temperature and **HOLD** will no longer blink or display.

2) Select FA or SL (Fast or Slow) Heat Pump stage Cycle Rate - The FA setting is used to produce shorter heating cycles. The SL setting produces a longer heating/cooling cycle. Both settings produce very accurate temperature control and can be set to your personal preference. FA cycles the system just under .75°F and the SL setting cycles at approximately 1.2°F.

3) Select FA or SL (Fast or Slow) Auxiliary or Emergency Cycle Rate - The FA setting is frequently used for gas, oil or electric heat. The SL setting produces a longer heating cycle. Both settings produce very accurate temperature control and can be set to your personal preference. FA cycles the system just under .6°F and the SL setting cycles at approximately 1.°F.





Configuration Menu

| Step | Press Button(s) | Displayed (Factory Default) | Press ▲ or ▼ to select: | COMMENTS |
|------|-------------------------------|-----------------------------|--|--|
| 1 | PRGM and RUN | HOLD (0:00) | 0 to 8 hrs (in 15 minute increments) | Select temporary Hold time |
| 2 | HOLD* | ❄ Δ (SL) | FA | Select FA or SL (Fast or Slow) pump cycle rate |
| 3 | HOLD* | EMER (FA) | SL | Select FA or SL (Fast or Slow) Auxiliary and Emergency Aux heating cycle rate |
| 4 | HOLD* | d-L (on) | OFF | Select display backlight OFF or ON |
| 5 | HOLD* | E (on) | OFF | Select Energy Management Recovery OFF or ON |
| 6 | HOLD* | Filter (000) | 0 to 1950 hours (in 50 hour increments) | Select filter replacement run time |
| 7 | HOLD* | LOC (OFF) | on | Select Compressor lockout OFF or ON |
| 8 | HOLD* | 0 HI (0) | 4 LO to 4 HI | Select temperature display adjustment higher or lower |
| 9 | HOLD* | (F) | C | Select temperature display to F or C |
| 10 | HOLD* | FA (on) | OFF | Select fast second stage ON or OFF |
| 11 | RUN | | | Returns to normal operation |

* Press **HOLD** to advance to next item or **TIME** to move backwards to previous item

- 4) **Select backlit display** - The display backlight improves display contrast in low lighting conditions. Selecting back-light ON will keep the light on continuously. Selecting OFF will keep the light off.
- 5) **Select Energy Management Recovery OFF or ON** - Energy Management Recovery (EMR) causes the thermostat to start heating or cooling early to make the building temperature reach the program setpoint at the time you specify.
- 6) **Select filter replacement run time** - The thermostat will display **FLTR** after a set time of operation. This is a reminder to change or clean your air filter. This time can be set from 0 to 1950 hours in 50 hour increments. **A selection of 000 will cancel this feature.** When **FLTR** is displayed, you can clear it by pressing **HOLD** and **RUN** at the same time. This resets the timer and starts counting the hours until the next filter change. Contact your heat pump manufacturer for a specific replacement/maintenance interval.
- 7) **Select Compressor Lockout LOC OFF or ON** - Selecting **LOC ON** will cause the thermostat to wait 5 minutes before turning on the compressor if the heating and cooling system loses power. It will also wait 5 minutes minimum between cooling or heating cycles. This is intended to help protect the compressor from short cycling. Some newer compressors already have a time delay built in and do not require this feature. Your compressor manufacturer can tell you if the lockout feature is already present in their system. When the thermostat compressor time delay occurs it will flash the **Snowflake** and **Flame** icons for about five minutes.
- 8) **Select Temperature Display Adjustment 4 LO to 4 HI** - Allows you to adjust the room temperature display up to 4° higher or lower. Your thermostat was accurately calibrated at the factory but you have the option to change the display temperature to match your previous thermostat. The current or adjusted room temperature will be displayed on the right side of the display.
- 9) **Select F° or C° Readout** - Changes the display readout to Celsius or Fahrenheit as required. The current room temperature will be displayed on the right side of the display.
- 10) **Select Fast second stage** - In the **RUN** mode, if the temperature is manually raised by 3°F (2°C) or more above room temperature using  and the fast second stage feature is enabled, **FA** on, the second stage will energize immediately. With **FA** off, the second stage will not energize until the setpoint temperature is 10°F or more above room temperature.

MANUAL OPERATION

- **HOLD TEMPERATURE** — With the **SYSTEM** switch set to **HEAT** or **COOL**, momentarily press **HOLD** button. **HOLD** will be displayed. Use  or  to adjust the temperature. The thermostat will hold the room temperature at the selected setting until you press **RUN** button to start program operation again.
- **TEMPERATURE OVERRIDE** — Press  or  until the temperature you want is displayed. The thermostat will override current programming and keep the room temperature at the selected temperature until the next program period begins. Then the thermostat will automatically revert to the program.
- **TEMPORARY HOLD TEMPERATURE** — The thermostat can hold any temperature within its range for the length of time selected in the configuration menu. See Configuration Menu section, step 1.

PROGRAMMING YOUR THERMOSTAT

This section will help you plan your thermostat's program to meet your needs. For maximum comfort and efficiency, keep the following guidelines in mind when planning your program.

- When heating (cooling) your building, program the temperatures to be cooler (warmer) when the building is vacant or during periods of low activity.
- During early morning hours, the need for cooling is usually minimal.

Planning Your Program

Look at the factory preprogrammed times and temperatures shown in the sample schedule. If this program will suit your needs, simply press the **RUN** button to begin running the factory preset program.

If you want to change the preprogrammed times and temperatures, follow these steps.

Determine the time periods and temperatures for your program. You must program four periods for each day. However, you may use the same heating and cooling temperatures for consecutive time periods. You can choose start times, heating temperatures, and cooling temperatures independently (for example, you may select 5:00 AM and 70° as the weekday **1st period heating** start time and temperature, and also choose 7:00 AM and 76° as the weekday **1st period cooling** start time and temperature).

SAMPLE
Heating/Cooling Schedule Plan (Factory Program)

| Period | WEEKDAYS (5 Day) | | SATURDAY (1 Day) | | SUNDAY (1 Day) | | |
|-------------|---------------------|----------|---------------------|----------|-------------------|----------|------|
| | Start Time | Temp | Start Time | Temp | Start Time | Temp | |
| HEAT | 1ST | 6:00 AM | 70°F | 6:00 AM | 70°F | 6:00 AM | 70°F |
| | 2ND | 8:00 AM | 62°F | 8:00 AM | 62°F | 8:00 AM | 62°F |
| | 3RD | 5:00 PM | 70°F | 5:00 PM | 70°F | 5:00 PM | 70°F |
| | 4TH | 10:00 PM | 62°F | 10:00 PM | 62°F | 10:00 PM | 62°F |
| COOL | 1ST | 6:00 AM | 78°F | 6:00 AM | 78°F | 6:00 AM | 78°F |
| | 2ND | 8:00 AM | 85°F | 8:00 AM | 85°F | 8:00 AM | 85°F |
| | 3RD | 5:00 PM | 78°F | 5:00 PM | 78°F | 5:00 PM | 78°F |
| | 4TH | 10:00 PM | 82°F | 10:00 PM | 82°F | 10:00 PM | 82°F |

Heating/Cooling Schedule Plan

| Period | WEEKDAYS (5 Day) | | SATURDAY (1 Day) | | SUNDAY (1 Day) | |
|-------------|---------------------|------|---------------------|------|-------------------|------|
| | Start Time | Temp | Start Time | Temp | Start Time | Temp |
| HEAT | 1ST | | | | | |
| | 2ND | | | | | |
| | 3RD | | | | | |
| | 4TH | | | | | |
| COOL | 1ST | | | | | |
| | 2ND | | | | | |
| | 3RD | | | | | |
| | 4TH | | | | | |



Use the table to plan your program time periods and the temperatures you want during each period. Fill in the complete table to have a record of your programs.

Entering Your Program





Set Current Time and Day

1. Press TIME button once. The display will show the hour only.

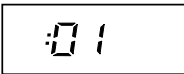
EXAMPLE: 

2. Press and hold either  or  until you reach the correct hour and AM/PM designation (**AM** begins at midnight; **PM** begins at noon).
3. Press TIME once again. The display window will show the minutes only.

EXAMPLE: 



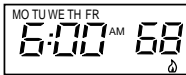

4. Press and hold either  or  until you reach the correct minutes.
5. Press TIME once again. The display will show the day of the week.
6. Press  or  until you reach the current day of the week.
7. Press RUN once. The display will show the correct time and room temperature alternately.

Enter Heating Program

1. Move the SYSTEM switch to **HEAT**.
2. Press PRGM once. "**MOTU WETH FR**" (indicating weekday program) will appear in the display. Also displayed are the currently programmed start time for the **1st heating** period and the currently programmed temperature (flashing).

EXAMPLE: 

This display window shows that for the 1st weekday period, the start time is 6:00 AM, and 68° is the programmed temperature (this example reflects factory preprogramming).

3. Press  or  to change the displayed temperature to your selected temperature for the 1st heating program period.
4. Press TIME once (the programmed time will flash). Press  or  until your selected time appears. The time will change in 15 minute increments. When your selected time is displayed, press TIME again to return to the change temperature mode.
5. Press PRGM once. The currently programmed start time and setpoint temperature for the **2nd heating** program period will appear.

6. Repeat steps 3 and 4 to select the start time and heating temperature for the 2nd heating program period.
7. Repeat steps 3 through 5 for the 3rd and 4th heating program periods.
8. Press PRGM once. "**SA**" (indicating Saturday program) will appear in the display, along with the start time for the 1st heating period and the currently programmed temperature.
9. Repeat steps 3 through 7 to complete Saturday heating programming.
9. Press PRGM once to change to **SU** (Sunday) heating programming and repeat steps 3 through 7 to complete Sunday programming.
11. When you have completed entering your heating program, press RUN.

Enter Cooling Program

CAUTION

If the outside temperature is below 50°F, disconnect power to the cooling system before programming. Energizing the air conditioner compressor during cold weather may cause personal injury or property damage.

1. Move SYSTEM switch to **COOL** position.
2. Follow **Enter Heating Program** for entering your cooling program, using your selected cooling times and temperatures.

CHECK YOUR PROGRAMMING

Follow these steps to check your thermostat programming one final time before beginning thermostat operation.

1. Move SYSTEM switch to **HEAT** position.
2. Press PRGM to view the 1st weekday heating period time and temperature. Each time you press PRGM, the next heating period time and temperature will be displayed in sequence for weekday, then Saturday and Sunday program periods (you may change any time or temperature during this procedure).
3. Press RUN.
4. Move SYSTEM switch to **COOL** position.
5. Repeat step 2 to check cooling program.
6. Move SYSTEM switch to **HEAT** or **COOL** and press RUN to begin program operation.

NOTE: Batteries are not required to keep your programming or menu data. With two optional "AA" batteries installed, your thermostat will maintain time and continuously display the temperature during a loss of AC power. Installed batteries will also allow programming prior to installation.

YOUR THERMOSTAT IS NOW PROGRAMMED AND READY TO PROVIDE MAXIMUM COMFORT AND EFFICIENCY!

TROUBLESHOOTING

Reset Operation

If a voltage spike or static discharge blanks out the display or causes erratic thermostat operation you can reset the thermo-

stat by pressing the reset button (see Fig 1). If the thermostat has power, has been reset and still does not function correctly contact your heating/cooling service person or place of purchase.

| Symptom | Possible Cause | Corrective Action |
|---|--|---|
| No Heat/No Cool/No Fan (common problems) | <ol style="list-style-type: none"> 1. Blown fuse or tripped circuit breaker. 2. Furnace power switch to OFF. 3. Furnace blower compartment door or panel loose or not properly installed. | <p>Replace fuse or reset breaker. Turn switch to ON. Replace door panel in proper position to engage safety interlock or door switch.</p> |
| No Heat | <ol style="list-style-type: none"> 1. System Switch not set to Heat. 2. Loose connection to thermostat or system. 3. Heating System requires service or thermostat requires replacement. | <p>Set System Switch to Heat and raise setpoint above room temperature. Verify thermostat and system wires are securely attached. Diagnostic: Set System Switch to Heat and raise the setpoint above room temperature. Within a five minutes the thermostat should make a soft click sound. This sound usually indicates the thermostat is operating properly. If the thermostat does not click, try the reset operation listed above. If the thermostat does not click after being reset contact your heating and cooling service person or place of purchase for a replacement. If the thermostat clicks, contact the furnace manufacturer or a service person to verify the heating system is operating correctly.</p> |
| No Cool | <ol style="list-style-type: none"> 1. System Switch not set to Cool. 2. Loose connection to thermostat or system. 3. Cooling System requires service or thermostat requires replacement. | <p>Set System Switch to Cool and lower setpoint below room temperature. Verify thermostat and system wires are securely attached. Same procedure as diagnostic for No Heat condition except set the thermostat to Cool and lower the setpoint below the room temperature. There may be up to a five minute delay before the thermostat clicks in Cooling if the compressor lock-out option is selected in the configuration menu (Item 7).</p> |
| Heat, Cool or Fan Runs Constantly. | <ol style="list-style-type: none"> 1. Possible short in wiring. 2. Possible short in thermostat. 3. Possible short in Heat/Cool/Fan system. 4. Fan Switch set to Fan On. | <p>Check each wire connection to verify they are not shorted or touching together. No bare wire should stick out from under terminal screws. Try resetting the thermostat as described below. If the condition persists, the manufacturer of your system or service person can instruct you on how to test the Heat/Cool system for correct operation. If the system operates correctly, replace the thermostat.</p> |
| Furnace Cycles Too Fast or Too Slow (narrow or wide temperature swing) | <ol style="list-style-type: none"> 1. The location of the thermostat and/or the size of the Heating System may be influencing the cycle rate. | <p>Item 2 in the Configuration Menu is the adjustment that controls the cycle rate. If an acceptable cycle rate is not achieved using the FA (Fast) or SL (Slow) adjustment contact a local service person for additional suggestions.</p> |
| Cooling Cycles Too Fast or Too Slow (narrow or wide temperature swing) | <ol style="list-style-type: none"> 1. The location of the thermostat and/or the size of the Cooling System may be influencing the cycle rate. | <p>The cycle rate for cooling is fixed and can not be adjusted. Contact a local service person for suggestions.</p> |
| Thermostat Setting and Thermometer Disagree | <ol style="list-style-type: none"> 1. Thermostat thermometer setting requires adjustment. | <p>The thermometer can be adjusted +/- 4 degrees as listed in item 8 of the Configuration Menu. No other adjustment is possible.</p> |
| Clock Loses or Gains Time | <ol style="list-style-type: none"> 1. Loss of power to thermostat. | <p>The thermostat will maintain its program in memory even with no power but the clock time will be incorrect when power is restored. See No Heat/No Cool/No Fan (common problems) above for items to check in the system.</p> |
| Heat or Cool Starts Early | <ol style="list-style-type: none"> 1. EMR activated | <p>See Configuration Menu (Item 5).</p> |
| Thermostat Does Not Follow Program | <ol style="list-style-type: none"> 1. AM or PM set incorrectly in program. 2. AM or PM set incorrectly on the clock. 3. Voltage spike or static discharge. | <p>Check current clock and program settings including the AM or PM designations for each time period. If a voltage spike or static discharge occurs use the Reset Operation listed above.</p> |
| Blank Display and/or Keypad Not Responding | <ol style="list-style-type: none"> 1. Voltage Spike or Static Discharge. | <p>If a voltage spike or static discharge occurs use the Reset Operation listed above.</p> |